

Side View

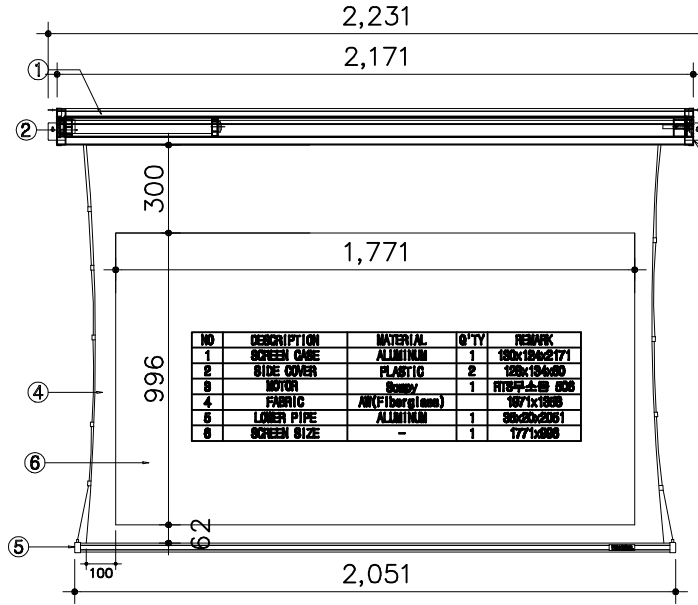

NO	DESCRIPTION	MATERIAL	Q'TY	REMARK
1	SCREEN CASE	ALUMINUM	1	180x184x2171
2	SIDE COVER	PLASTIC	2	128x194x80
3	MOTOR	Sony	1	FTDPL-200 200
4	FABRIC	AN(Fiberglass)	1	1871x1806
5	LOWER PIPE	ALUMINUM	1	30x20x2051
6	SCREEN SIZE	-	1	1771x996

전동T텐션스크린 T-EH80						단위:mm
16:9	80°	A	B	C	D	E
		1771	996	300	100	2231

-단위상의 치수는 단면도의 치수와 일치합니다. (단위 치수에 따라 달라지는 소수점 반올림입니다.)

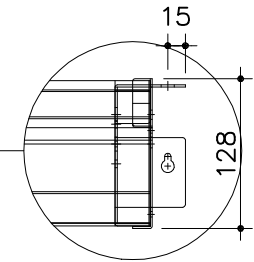

(주) 윤씨네
 경기도 화성시 팔명면 은전로 165번길 16-12
 Tel : 031-8059-3805~7
 Fax : 031-8059-3809
 Homepage : http://www.yuncne.com

-주의사항-

T-EH_80
 텐션노출 80

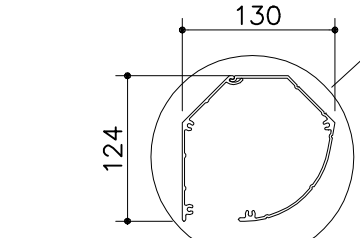

AL Case

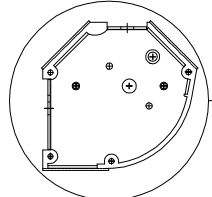

End Cap

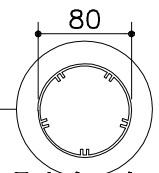
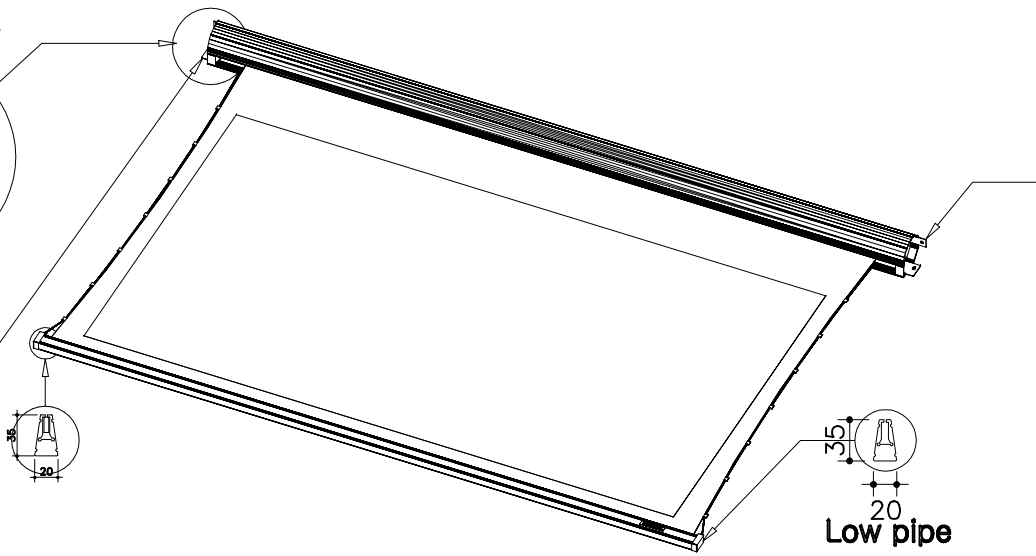

Fabric pipe

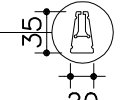

Low pipe

제 도 DRAWN BY	
검 도 CHECKED	
승 인 APPROVED	
재 료 MATERIAL	-
일 자 DATE	2014. 6.
확 도 SCALE	NONE
도 명 TITLE	
부 명 PART NAME	
조립도번호 ASSY DRA NO	
도 번호 DWG. NO.	-